



smartlink
Wifi Controller



**USER &
INSTALLATION
MANUAL**



spanet
Innovative Spa & Pool Solutions

Table of Contents

1. SmartLink module	3
1.1 Product overview	3
1.2 Hardware requirements	3
1.3 Module installation	4
2. Wifi internet access	6
2.1 SSID name and router password	6
2.2 Wifi signal strength	6
2.3 Indicator LEDs	7
3. Install the SpaLink App	7
3.1 Finding SpaLink App on iPad	8
4. Register a user account	8
5. SpaLink App setup process	10
5.1 Place the SmartLink module into Hot Spot mode	11
5.2 Complete app setup process	14
5.2.1 Apple iOS Devices	14
5.2.2 Android Devices	18
6. Voice control	22
6.1 How to link spa to Google Assistant	22
6.2 How to link spa to Amazon Alexa	25
6.3 Vocal assistance command list	28
7. Troubleshooting	29
7.1 Unable to locate SpaLink App on App Store	29
7.2 Problems with registration process	29
7.3 Unable to login to app	29
7.4 Cannot see the SV network in WiFi Setting during setup	30
7.5 Unable to connect to SV network during setup	30
7.6. Input socket error during setup process	31
7.7 Home WiFi network not detected during app WiFi scan	32
7.8 Spa not online after setup process	32
7.9 Spa was online but has dropped offline	33
8. Legal Information	34

1. SmartLink Module

The SmartLink WiFi module and SpaLink App lets you use an Apple® or Android™ smartphone or tablet as a wireless remote control for your SV Series equipped spa. Using simple touch screen menus, you can control all spa accessories including pumps, air blowers and LED spa lights. You can also configure your spa including adjustment of the temperature, selecting your desired heating mode, programming filtration, sleep or power save timers and more. Available anywhere, anytime, just as if you were standing in front of the spa, or better yet, sitting in it.

For a smooth and successful setup process you must complete each installation section and steps in their correct order:

1. WiFi Internet Access
2. Install the SpaLink App
3. Register a User Account
4. SpaLink App setup process

1.1 Product Overview

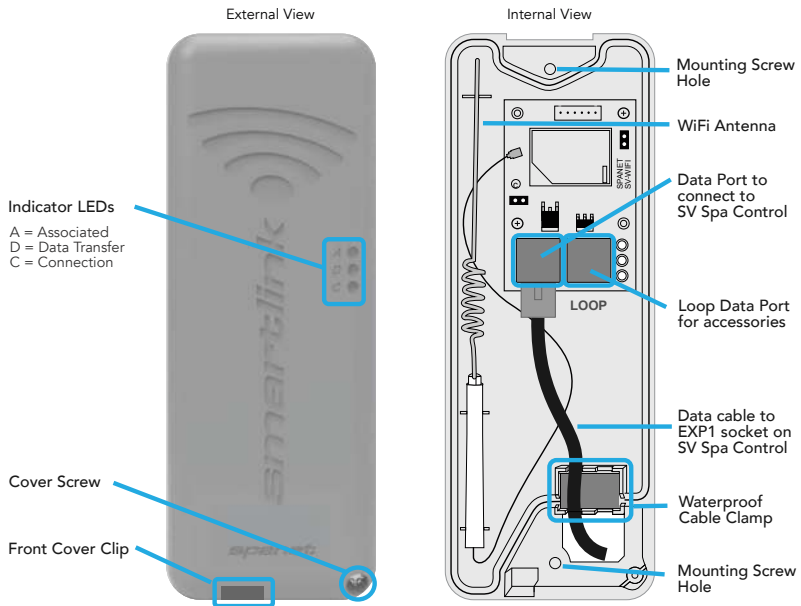

1.2 Hardware Requirements

Your SpaNET SV Series spa control must be fitted with the SV SmartLink WiFi module for the app to work. The SmartLink WiFi module requires a permanent active internet connection via a wireless router to operate. The Internet connection/router must remain powered on at all times for you to use the SpaLink App.



1.3 Module Installation

In most instances your SmartLink module will be pre-fitted under your spa cabinet by your spa manufacturer. Dependant on spa location, orientation, number and type of walls between spa and router, router signal output quality, insulation material used on spa cabinet and other factors, the wifi signal received under the spa cabinet may or may not be strong enough for reliable operation.

The SmartLink module has been designed as an external unit so if WiFi signal strength is weak, or your module has not been pre-fitted to your spa follow the steps below to mount the module external to the spa cabinet:

Step 1. Determine module location

Select a suitable position on or near the spa cabinet that will allow the WiFi module to receive the best signal reception from your WiFi router. i.e. on spa side closest to house, in a position with best line of sight from module to router. **NOTE: The module MUST be positioned in a vertical orientation for best signal strength, with the wifi symbol at the top to maintain waterproofing (Fig 1).**

*TIP: It may be wise to proceed through app setup process **BEFORE** affixing module to cabinet to ensure optimal signal strength position has been determined.*

Step 2: Open SmartLink module

Remove screw from bottom right corner of module. Depress front cover clip at bottom of module then remove cover by pulling the bottom of the front cover out and upwards in a swift motion. The top clip is a snap lock style which requires swift action to release. Do not open the cover slowly. Pull it out and upwards in a 45-degree angle quickly. It will then release easily (Fig 2).

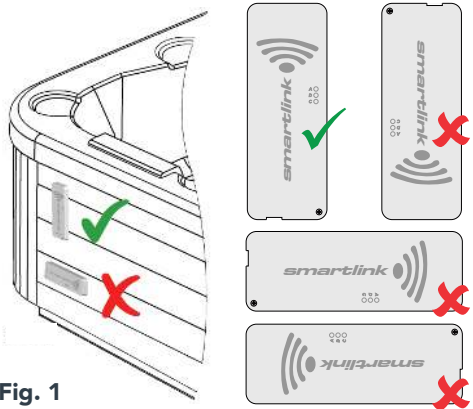

Fig. 1

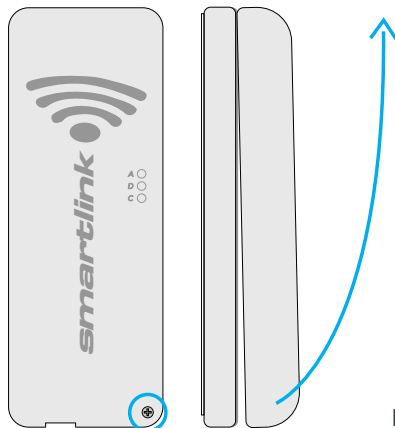

Fig. 2

Step 3: Affix module to cabinet

Once the ideal location has been determined, mark a position to drill a 16mm hole to feed the RJ data cable through the cabinet to allow you to connect the SmartLink module to your SV Series spa control (a 16mm spade drill bit is recommended). Once the cable has been fed through the cabinet, peel off the adhesive backing and affix module to cabinet. Then screw the backing plate to the cabinet using the screw holes as indicated aside (Fig 3). Re-attach front cover and tighten front cover screw.

NOTE: DO NOT overtighten backing plate mounting screws. If the screws are overtightened the backing plate may bend and prevent the front cover from sealing on the waterproof gasket when re-attached

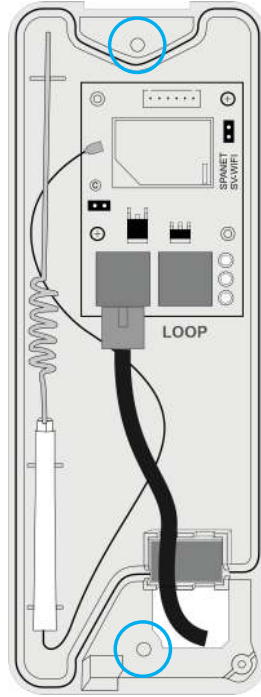
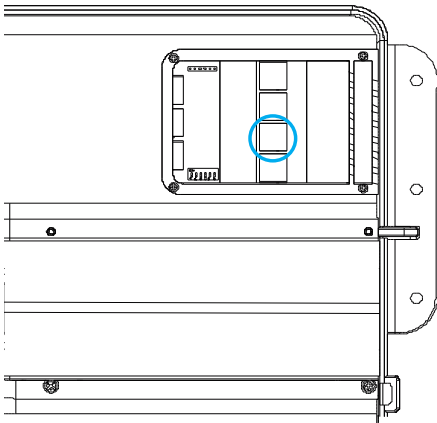

Fig. 3

Step 4: Connect data cable to SV spa control

The SmartLink RJ data cable **MUST** be connected to the **EXP1 (Expand Port 1)** socket on your SV spa control. The module **CANNOT** be connected to any other socket. The **EXP1** socket can be found in the top right-hand corner of your SV Series spa control, or on the top right side of the main PCB on your SV Mini spa control once the cover has been removed.



SV Series - EXP1 socket location

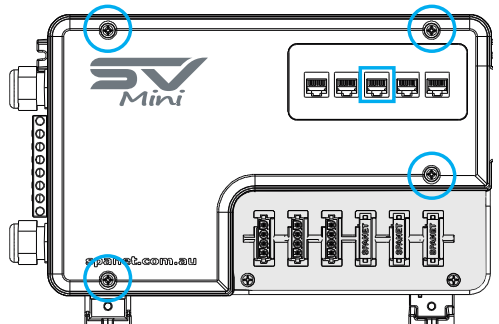

SV Mini - EXP1 socket location

Connecting SmartLink module when Expand Port 1 (EXP1) is already in use

Certain brand spas have features that utilise the Expand Port 1 socket. In this case when you attempt to connect the SmartLink Module the socket you need to connect to will already have a cable connected. In this situation the existing cable gets disconnected from the SV controller and re-connected inside of the SmartLink WiFi Module into the socket labelled LOOP, therefore allowing the SmartLink RJ data cable to be connected directly to the EXP1 socket on the SV controller as required.

2. Wifi Internet Access

The SmartLink WiFi module requires a permanent, active Internet connection via a wireless router to operate. To be able to access your spa from anywhere, at any time, the router must remain powered on at all times. WiFi signal strength is extremely important for stable, reliable app operation. If the WiFi signal is too weak, the app setup process may not be able to be completed or the spa could have intermittent connections and drop offs. In this situation the WiFi signal would need to be boosted/improved by either ensuring your SmartLink module is mounted external to the spa cabinet, relocating your router, installing an additional access point or WiFi range extender in closer proximity to the spa.

2.1 SSID Name and Router Password

Before beginning the Spalink App setup process you must be aware of your WiFi router's SSID name and password. Failure to have these login credentials on hand whilst you are beside the spa completing the setup process may lead to a failed setup. The login credentials may be labelled on the WiFi router and/or on a card your ISP supplied at time of installation. Please write them here for reference:

Router SSID name:

Router password:

NOTE: Your router password is case sensitive and must be entered 100% correct during the setup process for a successful installation. **The SmartLink module CANNOT interrogate your password to ensure it is correct. It relies on you entering it correctly.** If the password is entered incorrectly you will have to complete the setup process again.

2.2 WIFI Signal Strength

WiFi signal strength is extremely important for reliable communication between the SmartLink WiFi module and your router. A strong WiFi signal to the SmartLink will result in the app being stable, respond faster and the spa will remain online. A weak WiFi signal can cause the app to respond slowly, timeout or cause the spa to drop offline. During the setup process the app will display a list of wireless network SSIDs discovered in proximity to the spa. The signal strength of each network is detailed on the right-hand side in decibels (-db). The closer the value is to 0, the stronger the signal. This means that -64db is a stronger signal than -70db. A value of -70db or better is required for reliable operation.

NOTE: During the setup process you can use the refresh arrow in the top right corner to perform another WiFi scan and update the dB signal readings (Fig 4). This can be helpful if you are trying to determine the best position for mounting your SmartLink module or router.

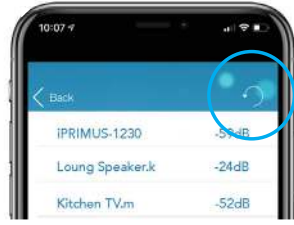

Fig. 4

2.3 Indicator LEDs

Associated (Red LED)

Fast Flash – module is NOT connected to a router or network
 Off – module IS successfully connected to a router or network

Data Transfer (Blue LED)

On or Flashing – data is being transferred

Connection Status (Green LED)

On Solid – Internet connection active and working OK
 Fast Flash – indicates no IP address assigned or module in command mode
 Slow Flash – indicates IP address is OK, but no TCP or Internet access

NOTE: By default, when the module is first connected to the SV spa control it should be in HOT spot mode ready for the SmartLink app setup process. The indicator LEDs will be flashing green and red.

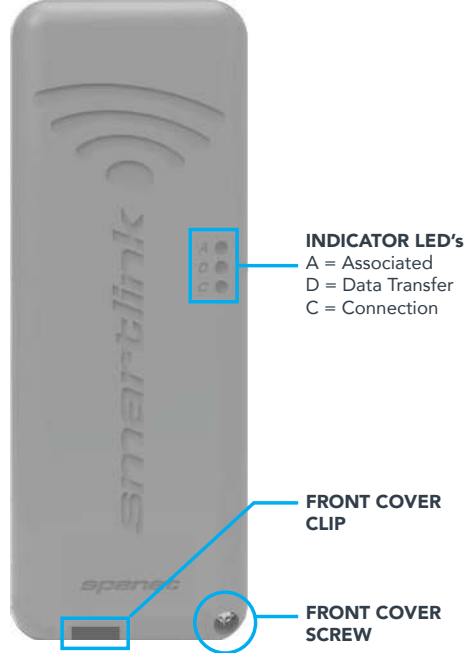

3. Install the SpaLink App

The SpaLink App is available for both Apple and Android devices.

Step 1: Open App Store / Google Play

Step 2: Search "SpaNET SpaLink"

Step 3: Press on install link to download and install app

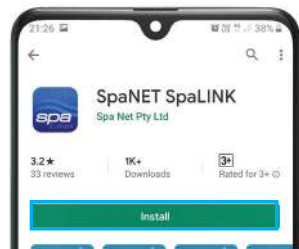

3.1 Finding SpaLink App on iPad

If you are using an iPad you may need to change the App Store to search for "iPhone only apps" instead of "iPad only apps". The iPhone app works successfully on the iPad.

4. Register an User Account

With the SpaLink app now installed you need to register a user account on our SpaNET cloud server which provides a secure login to access your spa. Think of it as the portal between the SpaLink app on your phone and the SmartLink module on your spa. Your user account allows for multiple SV controllers to be configured on the one account, in case you own a dual-zone swim spa or more than one spa.

NOTE: You only ever need to register ONE user account once, even if you wish to operate the app across multiple smart devices, concurrently or individually. Complete the user account registration on your first device and take note of the username and password you select during the registration process. On other devices, simply download and install the app and then enter the username and password you have already registered to login to the app. DO NOT complete multiple registrations on each new device. A spa can only be linked to one user account.

Step 1: Tap the SpaLink App icon to open the app.



Step 2: Tap REGISTER

Step 3: Tap in the Name field to enter your full name using the pop-up keyboard.

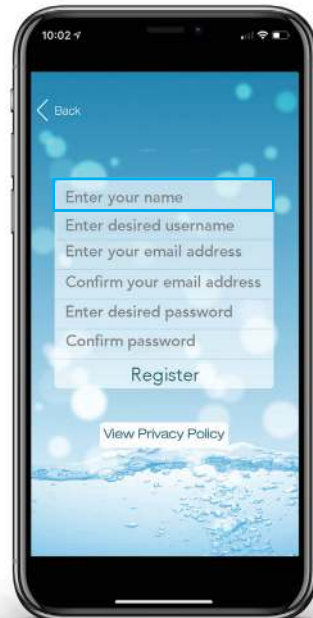
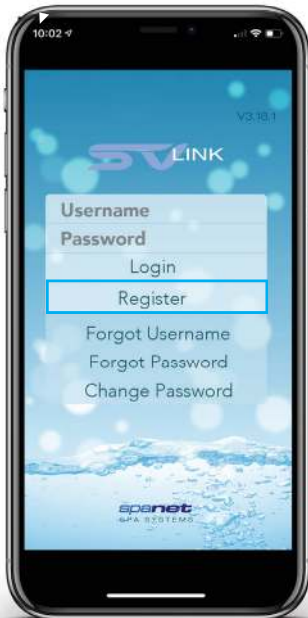

Step 4: Enter your desired username.



10:02

< Back

Enter your name

Enter desired username

Enter your email address

Confirm your email address

Enter desired password

Confirm password

Register

View Privacy Policy

The image shows a smartphone screen with a registration form. The form has a blue background with a water and bubbles pattern. The text is white. The 'Enter desired username' field is highlighted with a blue border. The 'Register' button is at the bottom of the form, and a 'View Privacy Policy' link is below it. The status bar at the top shows the time 10:02 and signal strength.

Step 5: Enter your email address.

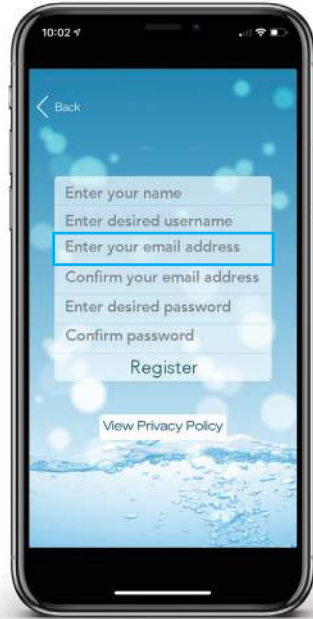

10:02

< Back

Enter your name

Enter desired username

Enter your email address

Confirm your email address

Enter desired password

Confirm password

Register

View Privacy Policy

The image shows a smartphone screen with a registration form. The form has a blue background with a water and bubbles pattern. The text is white. The 'Enter your email address' field is highlighted with a blue border. The 'Register' button is at the bottom of the form, and a 'View Privacy Policy' link is below it. The status bar at the top shows the time 10:02 and signal strength.

Step 6: Confirm your email address.



10:02

< Back

Enter your name

Enter desired username

Enter your email address

Confirm your email address

Enter desired password

Confirm password

Register

View Privacy Policy

The image shows a smartphone screen with a registration form. The form has a blue background with a water and bubbles pattern. The text is white. The 'Confirm your email address' field is highlighted with a blue border. The 'Register' button is at the bottom of the form, and a 'View Privacy Policy' link is below it. The status bar at the top shows the time 10:02 and signal strength.

Step 7: Enter your desired password.



10:02

< Back

Enter your name

Enter desired username

Enter your email address

Confirm your email address

Enter desired password

Confirm password

Register

View Privacy Policy

The image shows a smartphone screen with a registration form. The form has a blue background with a water and bubbles pattern. The text is white. The 'Enter desired password' field is highlighted with a blue border. The 'Register' button is at the bottom of the form, and a 'View Privacy Policy' link is below it. The status bar at the top shows the time 10:02 and signal strength.

Step 8: Confirm your password.

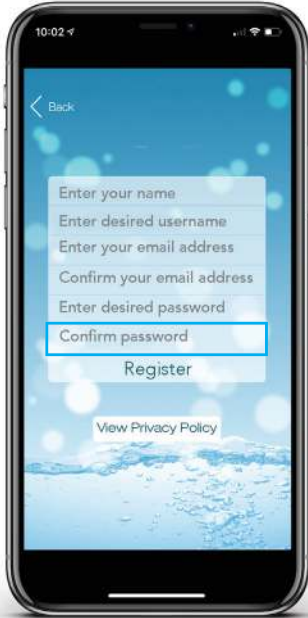

Step 9: Review your registration details then tap REGISTER to proceed.

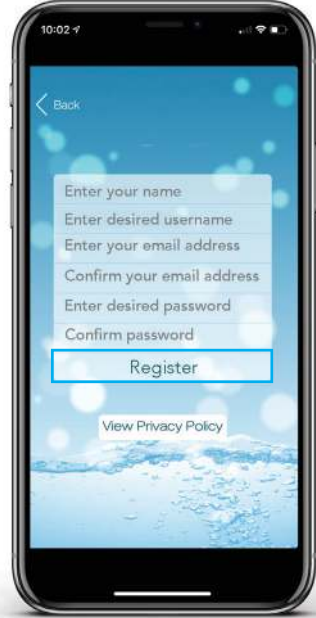

5. SpaLink App Setup Process

With the user account now registered, you need to configure the Internet access to your spa in the same way you would connect a laptop or TV to your WiFi router.

The setup process is a one-time event that programs the SmartLink WiFi module with your WiFi router's login credentials (SSID and password).

Login details are stored in the SmartLink WiFi module and remembered even if power is lost to the spa or router. Unless the router login details change, you shouldn't need to run the setup process again.

To complete the setup process, ensure that:

- Your smart device has an active WiFi, 3G or 4G Internet connection.
- You have the login credentials for your WiFi router (SSID name and password) at hand.
- Your router is using WPA/WPA2 security encryption by default. DO NOT use WEP encryption.

5.1 Place the SmartLink Module into Hot Spot Mode

Standard Keypads

Step 1: On you spa-side keypad, press and hold the UP + DOWN buttons simultaneously until the display shows [MODE].

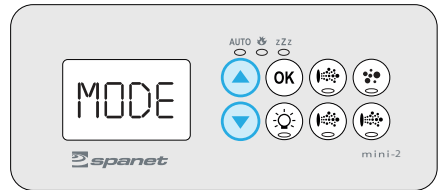
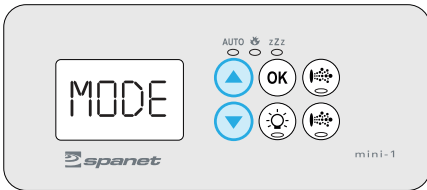
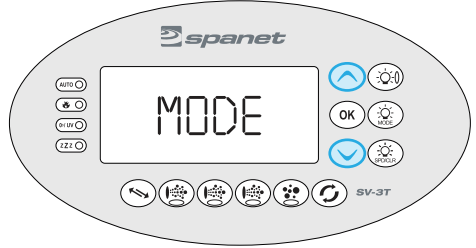
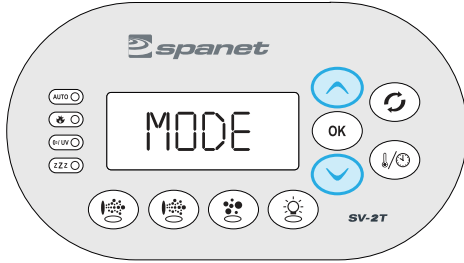

Step 2: Press the DOWN button multiple times until display shows [WIFI].

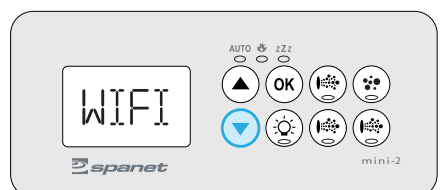
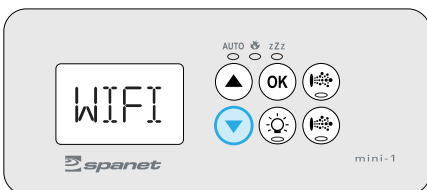
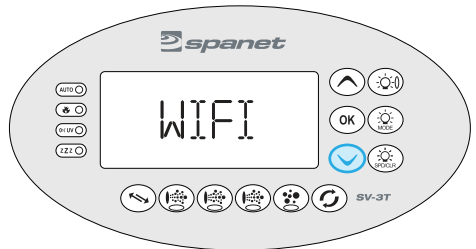
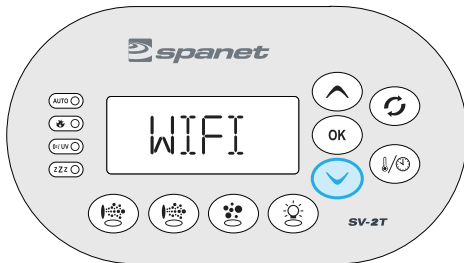

Step 3: Press the OK button to enter the WIFI menu => the display will show [HOT]. If HOT is not displayed press the DOWN button until it is.

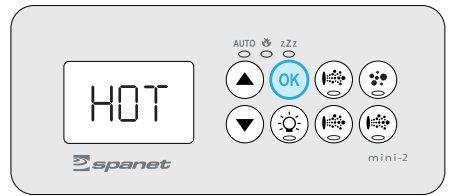
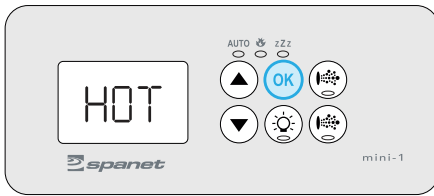
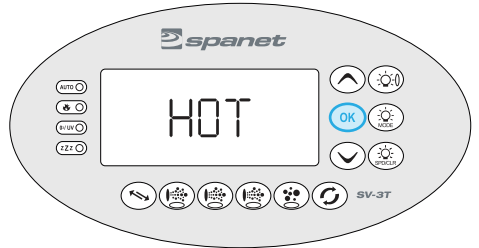
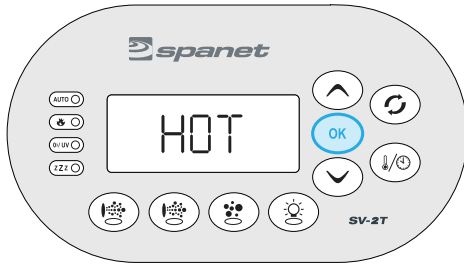

Step 4: Press the OK button to execute the Hot Spot mode command => the display will briefly show [WAIT] whilst the command is carried out.

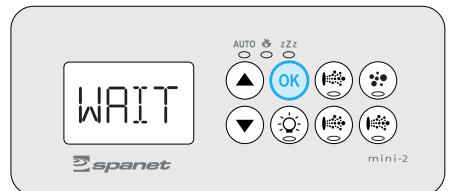
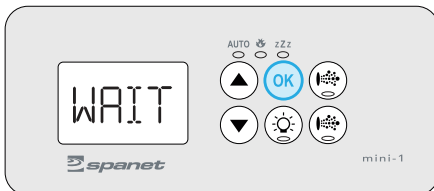

PLACE THE SMARTLINK MODULE INTO HOT SPOT MODE

SmartTouch Keypad

Step 1: On your touch panel, press the SETTINGS button in the bottom left corner of the screen => the General Settings menu will be displayed



Step 2: Scroll down through the menu and then press on the WIFI menu option => the WiFi menu screen will be displayed

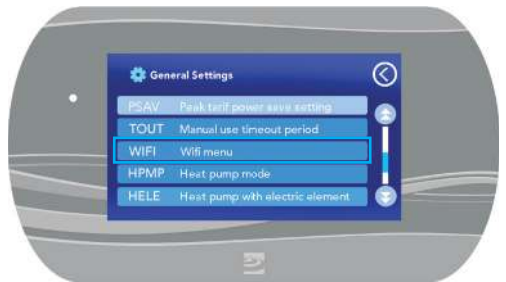

Step 3: If HOT is not displayed use the + or - minus buttons until HOT is displayed, then press the SAVE button to execute the Hot Spot mode command.



5.2 Complete App Setup Process

5.2.1 Apple iOS Devices

Step 1: Open app and press login. If you just registered, you will already be logged into this spa list screen.



Step 2: Tap the New Device bar.



Step 3: Press on the X button to close the pop-up box but DO NOT press the Setup bar yet.



Step 4: Press or slide your Apple home button and navigate to your Apple Settings.



Step 5: Enter the Apple WiFi settings and locate the SV WiFi network, which matches your spa control's serial number.



Step 6: Press on the SV network to connect to it. NOTE: No password is required to connect.



Wait for a moment to ensure the SV network is connected properly.

NOTE: If no SV network is found, repeat section 5.1 again to activate the SmartLink WiFi hot spot mode. If still unsuccessful follow Troubleshooting 7.4

Step 7: Tap SETUP bar once only to begin a WiFi scan and display a list of nearby wireless networks detected. *NOTE: Wait for the scan to complete before pressing anything else*

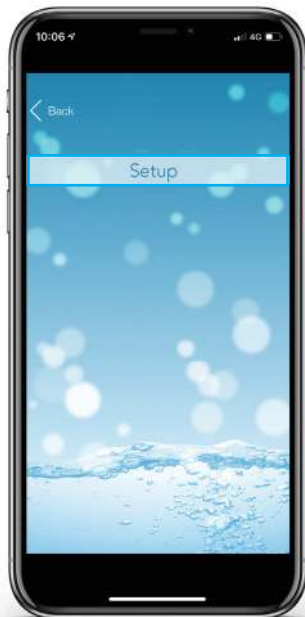

Step 8: Select the wireless network to connect your spa to, ensuring the signal strength is -70db or better. Or press the Refresh arrow in the top right to perform another WiFi scan.

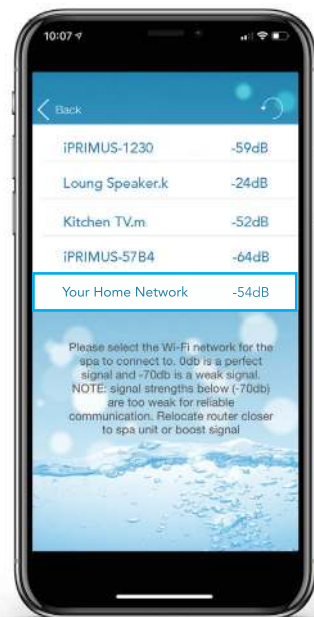

Step 9: Enter your router password to access your home wireless network.
NOTE: Take care, the app cannot check the password. It relies on correct entry.



Step 10: You have now confirmed the SSID and password for the WiFi network the spa will connect to. Press the OK button to continue.



Step 11: Press on the X button to close the pop-up box and then press or slide your Apple home button and navigate to your Apple WiFi settings



Step 12: The SV network should have disappeared and your phone should have reconnected to your home network. If not wait a moment, then manually connect to your home network.



Step 13: Navigate back to app and then enter a name for your spa and press on Register to complete the setup process.
NOTE: The name can be changed after setup if desired.



Step 14: The SmartLink module is now connecting to your router and preparing to come online. The spa will show offline at this point. It may take 2-5 mins for initial connection. Press refresh arrow to recheck status.



Step 15: The spa now shows as online, the WiFi signal strength is displayed and spa name can be changed using the Edit pencil. Press on the spa name to login to the spa.

To check your actual WiFi signal strength press on the WiFi bar graph icon.

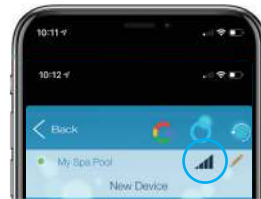

The signal strength is displayed in decibels with a time stamp of when that signal strength was taken. The signal will be updated every 5-10 minutes.



5.2.2 Android Devices

Step 1: Open app and press login. If you have just registered, you will already be logged into this spa list screen.



Step 2: Tap on New Device bar.



Step 3: Tap the X button to close the pop-up box. NOTE: Your device will launch straight into your Android WiFi Settings.



Step 4: Under Available Networks locate the SV WiFi network, which matches your spa control's serial number

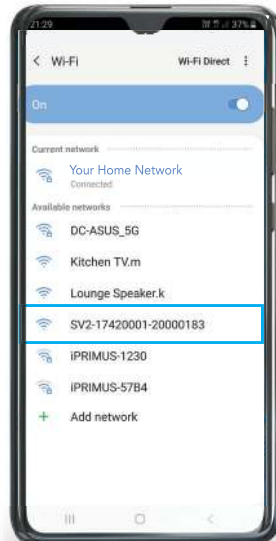

NOTE: If no SV network is found, repeat section 5.1 again to activate the SmartLink WiFi hot spot mode. If still unsuccessful follow Troubleshooting 7.4

Step 5: When you connect to the SV network, Android will present a pop-up advising the network does not have Internet access. Remain connected and simply wait for that pop-up to disappear.



Step 6: Once connected to the SV network, tap the Android Back button to re-enter the SpaLink app. **NOTE: DO NOT press the Home button, you MUST use the Back button to continue setup.**

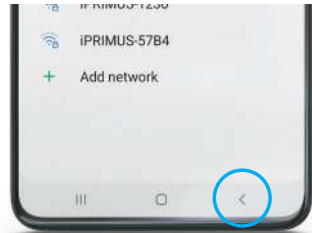

Step 7: Tap SETUP bar once only to begin a WiFi scan and display a list of nearby wireless networks detected. **NOTE: Wait for the scan to complete before pressing anything else.**

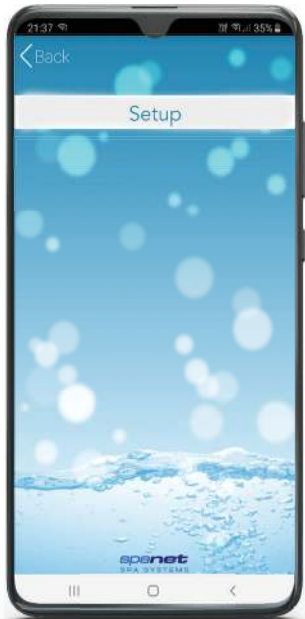

Step 8: Select the wireless network to connect your spa to, ensuring the signal strength is -70db or better. Or press the Refresh arrow in the top right to perform another WiFi scan.

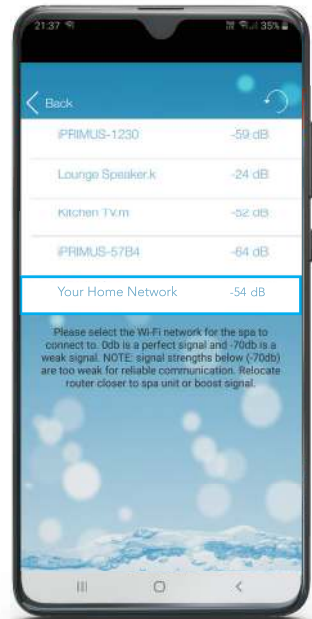

Step 9: Enter your router password to access your home wireless network.
NOTE: Take care, the app cannot check the password. It relies on correct entry.



Step 10: Tap the X button to close the pop-up box. *NOTE: Your device will launch straight into your Android WiFi Settings.*



Step 11: The SV network should have disappeared and your phone should have reconnected to your home network. If not wait a moment, then manually connect to your home network.

Step 12: Once connected to your home network, tap the Android Back button to re-enter the SpaLink app. *NOTE: DO NOT press the Home button, you MUST use the Back button to continue setup.*

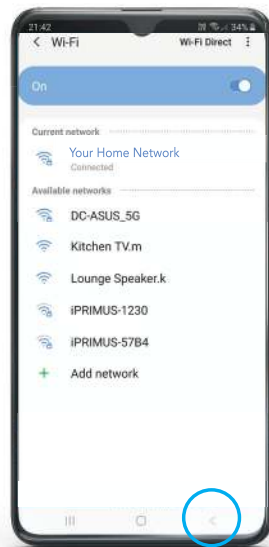
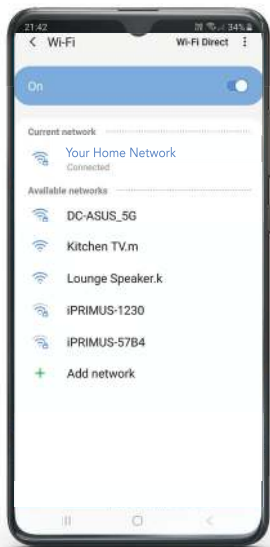

Step 13: Enter a name for your spa and press on Register to complete the setup process. *NOTE: The name can be changed after setup if desired.*



Step 14: The SmartLink module is now connecting to your router and preparing to come online. The spa will show offline at this point. It may take 2-5 mins for initial connection. Press refresh arrow to recheck status.



Step 15: The spa now shows as online, the WiFi signal strength is displayed and spa name can be changed using the Edit pencil. Press on the spa name to login to the spa.



To check your actual WiFi signal strength press on the WiFi bar graph icon.



The signal strength is displayed in decibels with a time stamp of when that signal strength was taken. The signal will be updated every 5-10 minutes.



6. Voice Control

The MySpaPool vocal skill allows you to control any spa pool fitted with our SmartLink or SmartStream WiFi module by voice commands. Available on both Google Assistant and Amazon Alexa platforms, you can now talk to your spa to activate accessories and alter settings or ask it questions about active modes, settings and status. It really is as simple as talking to your spa.

6.1 How to Link Spa to Google Assistant



Google Assistant

The following instructions assume you already have Google Assistant installed and activated on your phone or your Google Home device is powered on and connected to your home WiFi network.

Step 1: The first step is to link your SpaLink app to your Google account. Open SpaLink, tap Login and then tap Google logo at top of screen.

Step 2: The Google Sign-In page will be presented. Tap on the Sign In button at bottom of screen.



Step 3: Select your Google account. If you have multiple accounts, use the account that is linked to your Google Home device.

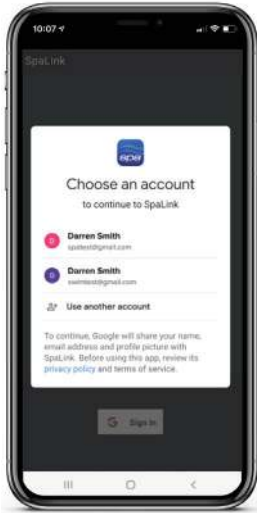

Step 4: The next step is to link your Google account to the mySpaPool action. Start by saying **"Hey Google, talk to my spa pool"**.



Step 5: When you answer 'Yes' to the link question you will see this screen. Tap Log In with Google to complete the account linking.

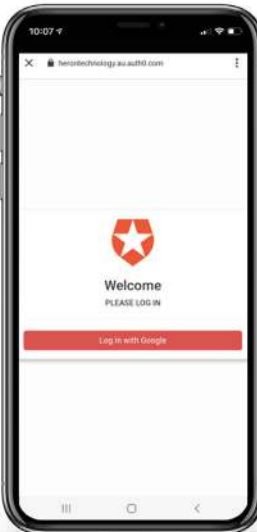

Step 6: The final step is to advise MySpaPool which spa to issue commands to. Start by saying **"Hey Google, talk to my spa pool"**.

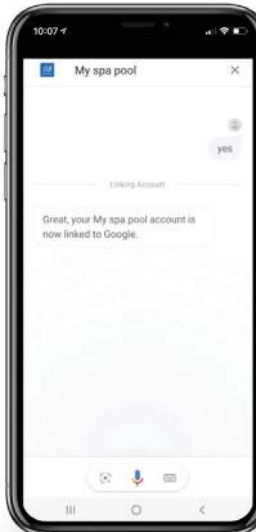

Step 7: Now say **“List my spa”** and Google will list any spas setup on your SpaLink app. Select the spa number (i.e. 1 or 2), not the spa name, to complete the link.



Setup Complete: The setup is now complete. You can begin issuing vocal commands to your spa. i.e. **“Hey Google... ask my spa pool... turn pumps on”**

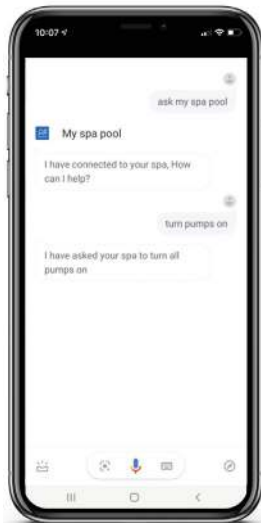

Change Spas: If you have a dual-zone spa or multiple spas you can switch between available spas by issuing the **“List my spa”** command at anytime.

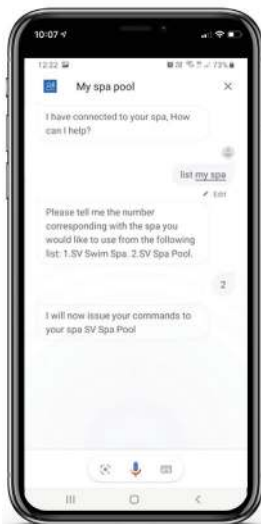

6.2 How to Link Spa to Amazon Alexa

The following instructions assume your Alexa device is powered on, connected to your home WiFi network and has been linked to your Amazon Alexa account.



Amazon Alexa

Step 1: The first step is to open the Amazon Alexa app and navigate to **Skills & Games** via the menu bar in the top left corner.

Step 2: Use the search bar to search for “My Spa Pool” and the skill will be displayed. Tap on the skill to select it.

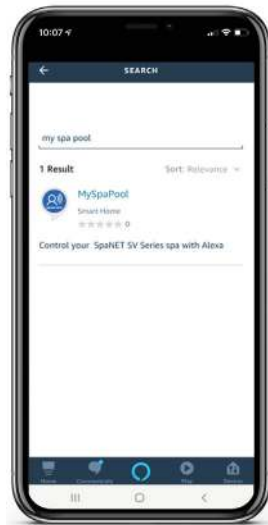

Step 3: The next step is to enable the skill, tap on the Enable bar.

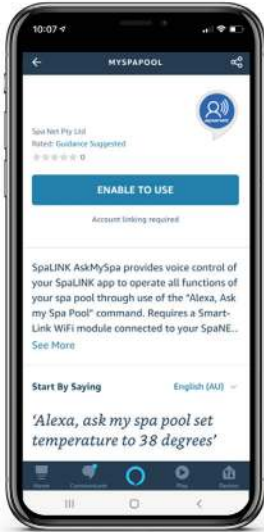

Step 4: You have now successfully linked the MySpaPool skill to your Amazon Alexa account. The next step is to link the SpaLink app to your Alexa account.

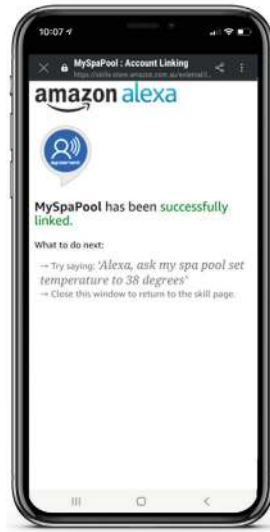

Step 5: Open SpaLink, tap Login and then tap on the Amazon Alexa logo at top of screen.



Step 6: Tap on the Login with Amazon button and confirm your acceptance to complete the account link with SpaLink.

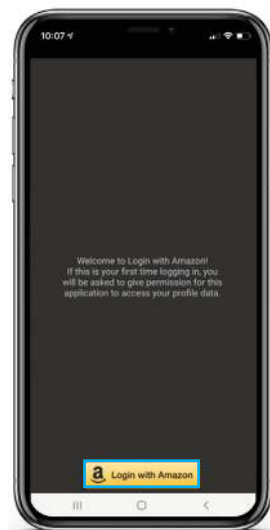

Step 7: With account linked, the final step is to confirm which spa to issue commands to. Start by saying, **“Alexa... start my spa pool”**.



Setup Complete: Now say **“List my spa”** and Alexa will list any spas setup on your SpaLink app. Select the spa number (i.e. 1 or 2), not the spa name, to complete the link.

Change Spas: You can now issue vocal commands to your spa. i.e. **“Hey Alexa... ask my spa pool... turn pumps on”**. To change spas issue the **“List my spa”** command again.

“Alexa, start my spa pool”

“I have connected to your spa, How can I help?”

“List my spa”

“Please tell me the number corresponding with the spa you would like to use from the following list: 1. SV Swim Spa. 2. SV Spa Pool.”

“one”

“I will now issue your commands to your spa SV Swim Spa”

“Alexa, ask my spa pool, turn pumps on”

“I have asked your spa to turn all pumps on”

“Alexa, ask my spa pool, list my spa”

“Please tell me the number corresponding with the spa you would like to use from the following list: 1. SV Swim Spa. 2. SV Spa Pool.”

“two”

“I will now issue your commands to your spa SV Spa Pool”

6.3 Vocal Assistance Command List



Google Assistant

Hey/OK Google... **ask my spa pool...**
<command>

OR

Hey/OK Google... **talk to my spa pool...**
<command>



Amazon Alexa

Hey Alexa... **ask my spa pool...**
<command>



Action commands

Start my spa
(all pumps/blower/lights on)

Stop my spa
(all pumps/blower/lights off)

Turn pumps on/off
(turns all pumps on/off)

Turn XXX pump on/off
(XXX = 1st, 2nd, 3rd or 4th)

Turn lights on/off
(lights turn on in last used mode)

Turn lights on XXX
(XXX = White, Fade, Step or Party)

Turn blower on/off

Start/Stop
Water Clean Cycle



Get Commands

What's the water temperature?
(actual water temp)

What's the target temperature?
(set temp point)

What's the operating mode?

What's the heat pump mode?

Current element boost state?



Set Commands

Set temperature to XX'C
(XX = 10'C to 40'C)

Set filtration to XX hours
(XX = 1 to 24)

Set operating mode to XXX
(XXX = Normal, Away or Week)

Set heat pump mode to XXX
(XXX = Auto, Heat, Cool or Off)

Set element boost mode to on/off

* Note: Can also use change, adjust or modify instead of set

7. Troubleshooting

7.1. Unable to locate SpaLink App on App Store

Problem	Causes	Solutions/Actions
Cannot find app when searching on an iPad device	Tap Filters to left of search bar and change from "iPad Only" to "iPhone Only"	On some devices the SpaLink App is listed as an iPhone only app

7.2 Problems with registration process

Problem	Causes	Solutions/Actions
"Username Taken" error when trying to register	Another user has already registered the username you entered	- Press YES to accept the alternative username suggested - Press NO to go back, enter a different username, then try register again
	You have already completed the registration process previously	Use the Forgot Password link on the Login page to recover your password
"Email address already registered" error when trying to register	A successful registration has already been completed with the email address entered	Use the Forgot Username or Forgot Password links on the Login page to recover your details

7.3 Unable to login to app

Problem	Causes	Solutions/Actions
App will not respond to Login press OR app crashes or hangs on spinning wait icon when attempting to Login OR "The Internet connection is offline" error when attempting to Login	Your smart device has no Internet connection OR you are connected to the SmartLink SV hot spot instead of your home WiFi network	Check that you are connected to your home WiFi network OR ensure mobile data is active if running off your phone carrier's cellular data Open a browser or a different app to confirm Internet is working OK on your device Disconnect from the SV network and reconnect to your home WiFi network

NOTE: If you are attempting to run the app setup process, DO NOT connect to the SV network hot spot until prompted by the app. You must have normal Internet connection to Login to the app and start the "New Device" process.

7.4 Cannot see the SV network in WiFi Setting during setup

Problem	Causes	Solutions/Actions
The SVx-xxxx-xxxx network is not showing in the WiFi settings list	The SmartLink WiFi module may not be in HOT mode	Repeat instructions from Section 5.1 – Place SmartLink module in Hot Spot Mode
	The SmartLink module is not releasing from your router from a prior failed setup	<p>Complete a master reset to HOT mode:</p> <ol style="list-style-type: none"> 1) Access the WIFI menu via your spa-side keypad 2) Press the UP or + button until display shows [RSET] 3) Press the OK or SAVE button to execute the RSET (reset) command 4) Wait for 20-30 seconds for the reset process to be completed 5) Reset mains power to spa (power spa OFF for 10 sec, then power spa back ON) 6) After priming cycle access the WIFI menu again via your spa-side keypad 7) Press the OK or SAVE button to execute the [HOT] command

NOTE: If you still cannot see the SV network in your WiFi list after following the above instructions, power OFF your router. Complete the 7 x steps above again (whilst the router is still powered OFF), then power your router back ON.

7.5 Unable to connect to SV network during setup

Problem	Causes	Solutions/Actions
"Unable to connect" error when selecting SV network from WiFi list	SmartLink module HOT mode has not executed properly	<p>Follow these steps in this exact order:</p> <ol style="list-style-type: none"> 1) Disconnect from SV network and reconnect to your home WiFi network 2) Force close SpaLink app 3) Access the WIFI menu via your spa-side keypad <p><i>Continues on next page</i></p>

Problem	Causes	Solutions/Actions
		4) Press the UP or + button until display shows [RSET] 5) Press the OK or SAVE button to execute the RSET (reset) command 6) Wait for 20-30 seconds for the reset process to be completed 7) Reset mains power to spa (power spa OFF for 10 sec, then power spa back ON) 8) Login to app and start setup process again

7.6 Input socket error during setup process

Problem	Causes	Solutions/Actions
"Input socket" error when pressing on Setup bar to conduct WiFi scan during setup process	SmartLink module HOT mode has not executed properly	Follow these steps in this exact order: 1) Force close the app 2) Go to your device WiFi settings, disconnect from the SV network and reconnect to your home WiFi network 3) Access the WIFI menu via your spa-side keypad 4) Press the UP or + button until display shows [RSET] 5) Press the OK or SAVE button to execute the RSET (reset) command 6) Wait for 20-30 seconds for the reset process to be completed 7) Reboot your phone or tablet 8) Reset mains power to spa (power spa OFF for 10 sec, then power spa back ON) 9) After priming cycle access the WIFI menu again via your spa-side keypad 10) Press the OK or SAVE button to execute the [HOT] command 11) Login to app and start setup process again

7.7 Home WiFi network not detected during app WiFi scan

Problem	Causes	Solutions/Actions
WiFi scan during setup hangs or reports "No network found"	The signal strength between SmartLink module and home router is too weak	<p>Take steps to improve WiFi signal strength to be -70dB or stronger</p> <ol style="list-style-type: none"> 1) Ensure module is positioned on spa side closest to house 2) Ensure module is positioned high enough with direct line of sight to router 3) Consider mounting module external to spa cabinet (refer Section 1.3) 4) Relocate router closer to spa 5) Install additional access point or WiFi extender in closer proximity to spa

7.8 Spa not online after setup process

Problem	Causes	Solutions/Actions
Setup process completed successfully but spa always showing offline status	SmartLink module has not switched out of HOT mode successfully	<p>Execute the INFR command to force a reconnection with the SpaNET App Server:</p> <ol style="list-style-type: none"> 1) Access the WIFI menu via your spa-side keypad 2) Press the UP or + button until display shows [INFR] 3) Press the OK or SAVE button to execute the INFR (infrastructure) command 4) Wait for 1-2 minutes and check spa online/offline status
	Incorrect router password entered during app setup process	<p>Check the LED indicator lights on the SmartLink module => if the RED light is flashing it indicates the router password was incorrectly entered during the setup process. In this instance you will need activate HOT mode, delete the spa and run setup again:</p>

Problem	Causes	Solutions/Actions
	WiFi signal between SmartLink module and router too weak	1) Execute the HOT command via the WIFI menu on your spa-side keypad 2) Click on the Edit pencil on the offline spa, then press DELETE 3) Press on New Device and run the app setup process again 4) Be sure to take extra time and care when entering your router password
		Check the LED indicator lights on the SmartLink module => if the RED light is OFF, and GREEN light is flashing it indicates a problem with weak WiFi signal strength. Take steps to improve signal strength (refer solutions in Section 7. 7)

7.9 Spa was online but has dropped offline

Problem	Causes	Solutions/Actions
Spa was working but has now dropped offline and is failing to reconnect	Connection between the spa and your router has been lost	Execute the INFR command to force a reconnection with the SpaNET App Server: 1) Access the WIFI menu via your spa-side keypad 2) Press the UP or + button until display shows [INFR] 3) Press the OK or SAVE button to execute the INFR (infrastructure) command 4) Wait for 1-2 minutes and check spa online/offline status If the above steps do not work reboot your router (power OFF / ON)
	WiFi signal between SmartLink module and router too weak	Take steps to improve signal strength (refer solutions in Section 7. 7)

8. Legal Information

The *Bluetooth*® word mark and logos are registered trademarks owned by Bluetooth SIG, Inc. and any use of such marks by Spa Net Pty Ltd is under license. Other trademarks and trade names are those of their respective owners.

Apple® and App Store are trademarks of Apple Inc., registered in the U.S. and other countries.

Android® and Google Playware trademarks of Google Inc.

Contains Transmitter Module FCC ID: T9J-RNS2

Contains Transmitter Module FCC ID: T9J-RN131,171

This device complies with Part 15 of the FCC Rules. Operation is subject to the following two conditions: (1) this device may not cause harmful interference, and (2) this device must accept any interference received, including interference that may cause undesired operation.

This equipment has been tested and found to comply with the limits for a Class B digital device, pursuant to part 15 of the FCC Rules. These limits are designed to provide reasonable protection against harmful interference in a residential installation. This equipment generates, uses and can radiate radio frequency energy, and if not installed and used in accordance with the instructions, may cause harmful interference to radio communications. However, there is no guarantee that interference will not occur in a particular installation. If this equipment does cause harmful interference to radio or television reception, which can be determined by turning the equipment off and on, the user is encouraged to try to correct the interference by one or more of the following measures:

- Reorient or relocate the receiving antenna.
- Increase the separation between the equipment and receiver.
- Connect the equipment into an outlet on a circuit different from that to which the receiver is connected.
- Consult the dealer or an experienced radio/TV technician for help.

To satisfy FCC RF Exposure requirements for mobile and base station transmission devices, a separation distance of 20 cm or more should be maintained between the antenna of this device and persons during operation. To ensure compliance, operation at closer than this distance is not recommended. The antenna(s) used for this transmitter must not be co-located or operating in conjunction with any other antenna or transmitter.

Spa Net Pty Ltd

4/103 Railway Road North,
Mulgrave NSW 2756, Australia

Phone: +61 2 4587 7766

Facsimile: +61 2 4587 8766

Email: service@spanet.com.au

Website: www.spanet.com.au

