



# TechBook

## in.mix 300

LED controller & power supply



a lighting control console at your fingertips

up to 3 different color zones

the power to illuminate





---

## Table of contents

Safety instructions.....	2
Warnings .....	3
Introduction .....	5
Overview .....	6
Dimensions .....	7
Installation .....	8
Connections	
- Preparation .....	9
- Compatible LED lights .....	11
- Other compatible LED lights via an adapter not provided .....	12
- Other connections .....	14
Compatible keypads .....	15
Troubleshooting .....	16
Specifications .....	17



## Safety instructions



**CAUTION**  
RISK OF ELECTRIC SHOCK  
DO NOT OPEN



**CAUTION:** TO REDUCE THE RISK OF ELECTRIC SHOCK, DO NOT REMOVE SCREWS ON THE BACK OF THE ENCLOSURE. NO USER-SERVICEABLE PARTS INSIDE. REFER SERVICING TO QUALIFIED SERVICE PERSONNEL.



The lightning flash with the arrowhead symbol within an equilateral triangle is intended to alert the user to the presence of uninsulated “dangerous voltage” within the product’s enclosure that may be of sufficient magnitude to constitute a risk of electric shock to persons.



The exclamation point within an equilateral triangle is intended to alert the user to the presence of important operating and maintenance (servicing) instructions in the service literature accompanying this appliance.



### **IMPORTANT SAFETY INSTRUCTIONS:**

For your own safety please read the following important safety instructions carefully before attempting to connect this unit to the mains power supply. They will also enable you to get the best performance from and prolong the life of the unit:

- \* READ THESE INSTRUCTIONS.
- \* KEEP THESE INSTRUCTIONS.
- \* HEED ALL WARNINGS.
- \* FOLLOW ALL INSTRUCTIONS.
- \* CLEAN ONLY WITH DRY CLOTH. BEWARE THE APPLICATION OF SOME PRODUCTS COMMONLY USED AGAINST CORROSION (SUCH AS WD-40 FAMILY PRODUCTS) AS THEY COULD DAMAGE THE ENCLOSURE, DUE TO A NEGATIVE CHEMICAL REACTION BETWEEN SOME INDUSTRIAL OILS AND ITS PLASTIC ENCLOSURE. ANY OTHER MATERIALS WHICH MAY COME IN CONTACT WITH THE ENCLOSURE MUST BE CAREFULLY EVALUATED UNDER END USE CONDITIONS FOR COMPATIBILITY.
- \* DO NOT INSTALL NEAR ANY HEAT SOURCES. CLEARANCE AND MINIMUM DISTANCE BETWEEN THE VARIOUS PARTS OF THE APPLIANCE AND THE SURROUNDING STRUCTURE ARE NOT SPECIFIED AS LONG AS THEY ARE SUFFICIENT SO THAT THE AMBIENT TEMPERATURE AROUND THE APPARATUS DOES NOT EXCEED 140°F (60°C).
- \* DO NOT DEFEAT THE SAFETY PURPOSE OF THE POLARIZED OR GROUNDING-TYPE PLUG. A POLARIZED PLUG HAS TWO BLADES WITH ONE WIDER THAN THE OTHER. A GROUNDING TYPE PLUG HAS TWO BLADES AND A THIRD GROUNDING PRONG. THE WIDE BLADE OR THE THIRD PRONG ARE PROVIDED FOR YOUR SAFETY. IF THE PROVIDED PLUG DOES NOT FIT INTO YOUR OUTLET, CONSULT AN ELECTRICIAN FOR REPLACEMENT OF THE OBSOLETE OUTLET.
- \* PROTECT THE POWER CORD FROM BEING WALKED ON OR PINCHED PARTICULARLY AT PLUGS, CONVENIENCE RECEPTACLES, AND THE POINT WHERE THEY EXIT FROM THE APPARATUS.
- \* ONLY USE ATTACHMENTS/ACCESSORIES SPECIFIED BY THE MANUFACTURER.
- \* UNPLUG THIS APPARATUS DURING LIGHTNING STORMS OR WHEN UNUSED FOR LONG PERIODS OF TIME.
- \* REFER ALL SERVICING TO QUALIFIED SERVICE PERSONNEL. SERVICING IS REQUIRED WHEN THE APPARATUS HAS BEEN DAMAGED IN ANY WAY, SUCH AS POWER-SUPPLY CORD OR PLUG IS DAMAGED, LIQUID HAS BEEN SPILLED OR OBJECTS HAVE FALLEN INTO THE APPARATUS, THE APPARATUS HAS BEEN EXPOSED TO RAIN OR MOISTURE, DOES NOT OPERATE NORMALLY, OR HAS BEEN DROPPED.
- \* THIS APPLIANCE INCORPORATES AN EARTH CONNECTION FOR FUNCTIONAL PURPOSES ONLY.

Aeware®, Gecko®, and their respective logos are Registered Trademarks of Gecko Alliance Group.  
in.mix 300™, in.stream 2™, in.k1000™, in.k800™, in.k500™ and their respective logos are Trademarks of Gecko Alliance Group.

All other product or company names that may be mentioned in this publication are tradenames, trademarks or registered trademarks of their respective owners.



---

## Warnings



### **WARNINGS:**

Before installing or connecting the unit, please read the following.

---

- \* DO NOT DISASSEMBLE OR ALTER THE APPARATUS.
- \* DO NOT USE FOAM TO ISOLATE THE UNIT.
- \* TURN POWER OFF BEFORE SERVICING OR MODIFYING ANY CABLE CONNECTIONS IN THIS UNIT.
- \* TO PREVENT ELECTRIC SHOCK HAZARD AND/OR WATER DAMAGE TO THIS APPARATUS, ALL CONDUITS MUST BE PLUGGED WITH THE ATTACHED GASKET.
- \* IN.MIX ENCLOSURE SHALL BE LOCATED ABOVE THE FLOOD ZONE WHERE THEY ARE UNLIKELY TO BE SUBMERGED IN THE EVENT THE SPA IS OVERFILLED (OR SIMILAR ABNORMAL CONDITION OCCURENCE).
- \* PRODUCT MUST BE DISPOSED OF SEPARATELY FROM NORMAL HOUSEHOLD IN ACCORDANCE WITH LOCAL WASTE DISPOSAL LEGISLATION.



### **WARNINGS:**

When this equipment is provided as an audio/video components for spas, U1563 - 6th edition requires that the following instructions (or equivalent) be provided as part of the instruction manual for the spa equipment.

---

- \* "CAUTION – RISK OF ELECTRIC SHOCK. DO NOT LEAVE COMPARTMENT DOOR OPEN";
- \* "CAUTION – RISK OF ELECTRIC SHOCK. REPLACE COMPONENTS ONLY WITH IDENTICAL COMPONENTS";
- \* WARNING – TO PREVENT DAMAGE, FIRE AND ELECTOCUTION DO NOT CONNECT LIGHT ASSEMBLY CABLE THAT HAS NOT BEEN APPROVED BY GECKO
- \* DO NOT SERVICE THIS PRODUCT YOURSELF AS OPENING OR REMOVING COVERS MAY EXPOSE YOU TO DANGEROUS VOLTAGE OR OTHER RISK OF INJURY. REFER ALL SERVICING TO QUALIFIED SERVICE PERSONNEL.
- \* WHEN THE POWER SUPPLY CONNECTIONS OR POWER SUPPLY CORD(S) ARE DAMAGED; IF WATER IS ENTERING THE IN.MIX ENCLOSURE OR ANY ELECTRICAL EQUIPMENT COMPARTMENT AREA; IF THE PROTECTIVE SHIELDS OR BARRIERS ARE SHOWING SIGNS OF DETERIORATION; OR IF THERE ARE SIGNS OF OTHER POTENTIAL DAMAGE TO THE UNIT, TURN OFF THE UNIT AND REFER SERVICING TO A QUALIFIED SERVICE PERSONNEL.
- \* THIS UNIT SHOULD BE SUBJECTED TO PERIODIC ROUTINE MAINTENANCE (FOR EXAMPLE, ONCE EVERY 3 MONTHS) TO MAKE SURE THAT THE UNIT IS OPERATING PROPERLY.
- \* PRODUCT MUST BE DISPOSED OF SEPARATELY FROM NORMAL HOUSEHOLD IN ACCORDANCE WITH LOCAL WASTE DISPOSAL LEGISLATION.





## Introduction



## in.mix 300

### LED controller & power supply for your spa

The in.mix 300 provides the low voltage required to power the RGB LED fixture of your spa.

When connected to one of our X or Y series control systems for spas and hot tubs, in.mix transforms our keypads in real lighting consoles with a perfect interface. Create your personalized ambiance easily with an infinite selection of colors and a light intensity dimmer.

The in.mix comes with a built-in power supply and can be connected to a 120V or 240V output of your spa's control system. It goes perfectly with the in.lu.me LED light system and gives up to 120 RGB light points in 3 different zones to illuminate the water in your spa or create color accents around it.



## Overview

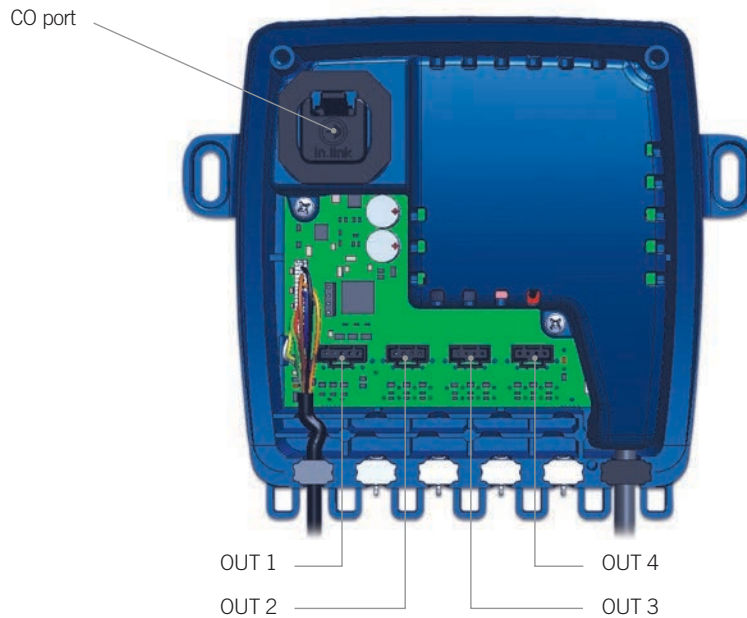

The in.mix 300 module supports 3 LED zones.

Zone 1 supports 2 types of connexions (A and B). The type A connection is made for 5 pin LEDs and the type B connection is for 4 pin LEDs (see page 9 for the pin functions). It is important to note that these 2 connections, OUT 1 (Type A) and OUT 2 (Type B), will always output the same color, since they are in the same Zone 1.

All zones may be used at the same time, but the total permissible power should always be respected (see [connections](#) section).

Table of correspondence between zones and connections:

Connector	Zone
OUT1	1
OUT2	1
OUT3	2
OUT4	3

This is the default zone assignment for each output. The low level configuration of the pack can be configured for a different zone assignment. Please refer to the low level specifications.

### Status light (optional)

When you assign a zone to have the status light functionality, it can help you diagnose problems on your spa.

- Blue light flashing: Maintenance reminder
- Blue light on: Everything is normal
- Red light flashing: You've lost communication on your spa
- Red light on: You have a problem on your spa



## Dimensions

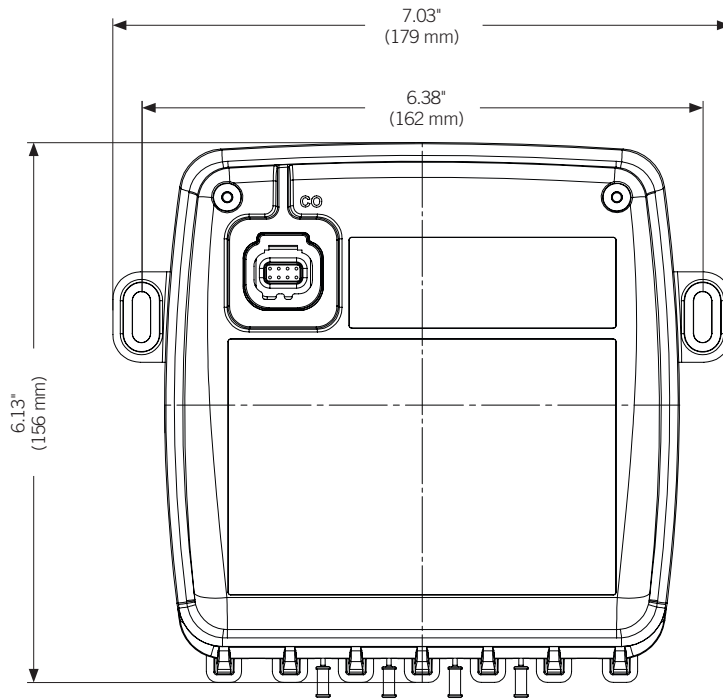

Front view

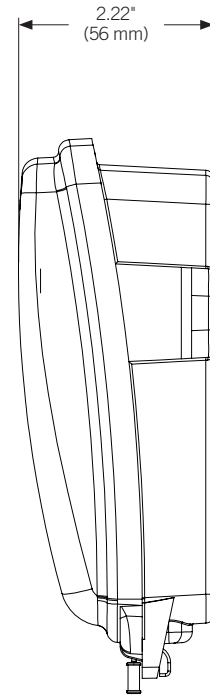

Side view





## Installation

To prevent water from getting inside the device, the in.mix 300 should be installed on a vertical surface as shown below:



### Secure the in.mix 300

Firmly attach upper mounting holes one at a time on each side of the apparatus.

### The following material is recommended:

2 - # 10 screws of appropriate length with round, truss or pan head.

2 - washers 0.5" OD x .0625" thickness  
(12 mm OD x 1.5 mm)



## Connections

### Preparation



To prevent electric shock hazard, do not connect to main power supply while the cover is removed.



Remove the cover screws from the front of the apparatus with a Phillips screw driver.  
**Before closing, please make sure the in.mix 300 gasket is well in place.**

Remove all seals and insert LED wire. Repeat for every LED lights you need to connect.

The in.mix 300 powers the LEDs with DC current\*\*. No matter the quantity of LEDs or their placement (Out 1 to Out 4), the in.mix 300 can provide a maximum of 1.6A. Every color (red, green or blue) is controlled independently through switching.

The in.mix 300 does not include a current limiting resistor for the outputs, so they must be **included in your LED lighting systems**. One must not connect a LED (or other light) directly to any output.

Connectors Out 2, Out 3 and Out 4 offer the following connections. The switching transistors are on the in.mix 300.

Pin	Function
1	BLUE (switched ground)
2	GREEN (switched ground)
3	RED (switched ground)
4	$V_{cc}$

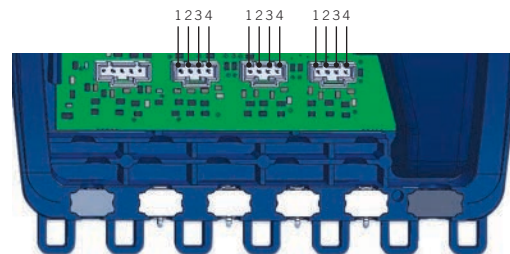

Connector Out 1 offers the following connections. For this output, the switching transistors are included with the LEDs, which is standard with "cluster" type models.

Pin	Function
1	BLUE (TTL output, High=on)
2	GREEN (TTL output, High=on)
3	RED (TTL output, High = on)
4	+12V
5	0V

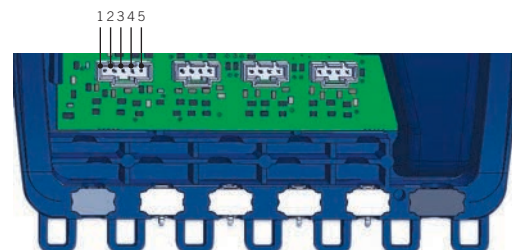

\*\* The output voltage is switched to simulate the power of a 5V output.



## Connections

### Connection for the in.lu.me Output version:

The in.mix 300 is compatible with in.lu.me series LED connectors.

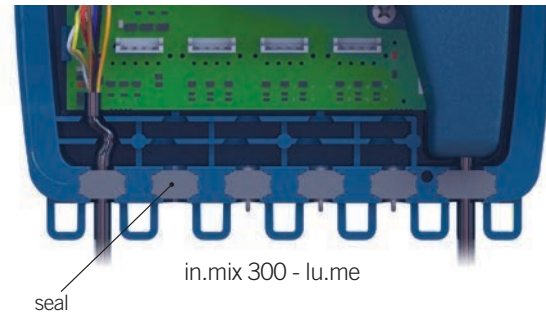

### Connection for the 5VDC Output version:

The in.mix 300 is compatible with Molex's SL series LED connectors.

Female Housing 4 Pos : #50-57-9404

Female Housing 5 Pos : #50-57-9405

Pin Female part number (AWG 22-24) : #16-02-0102

\*\* The output voltage is switched to simulate the power of a 5V output.

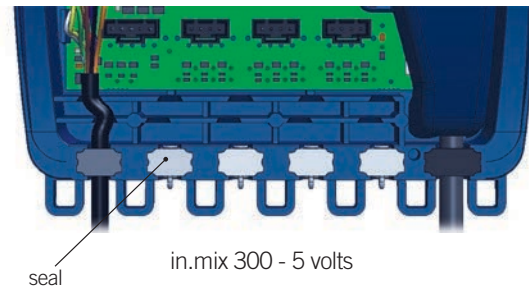

### Connection for the 12VDC Output version:

The in.mix 300 is compatible with MTA-100 series LED connectors.

Female Housing 4 POS : #3-643814-4 (AWG24)

Female Housing 5 POS : #3-643814-5 (AWG24)

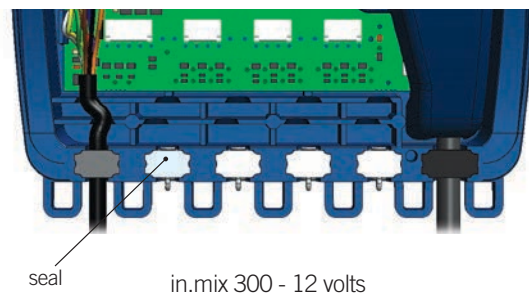



---

## Connections

### Compatible LED lights

The in.mix-300-lu.me (0609-521009) is directly compatible with Gecko in.lu.me light systems and supports up to 120 LEDs distributed over its four outputs (60 LEDs on outputs OUT1 and OUT2 and 60 LEDs on outputs OUT3 and OUT4 max).

If you do not use the Gecko lights system in.lu.me, contact Gecko Alliance to determine if the LED models you plan on using are compatible.

If J&J Electronics Inc.'s *Spyder* LEDs from their ColorCHOICE™ series are used, a maximum of 100 are supported by the in.mix-300. They may be distributed in any way through the 3 Zones.

The Out 1 is compatible with the J&J cluster.

If choosing J&J Electronics, please note the in.mix 300 comes in "plug and play" version (# 0609-521005) with adapters included as seen here:

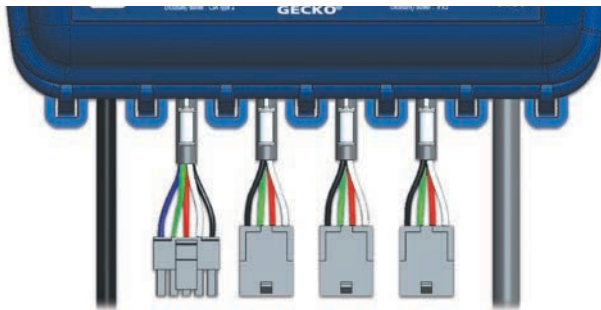

Different options are available according to the situation. Please note you can only have a "plug and play" model with J&J Electronics.



# Connections

## Other compatible LED lights via an adapter not provided

### Rosstech

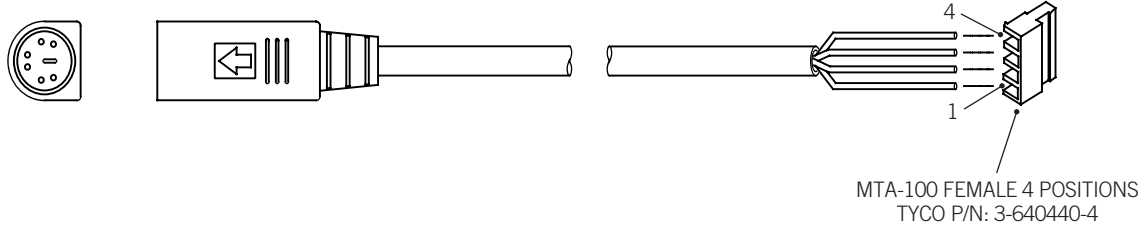

Pin	Function
1 (red)	BLUE
2 (green)	GREEN
3 (white)	RED
4 (black)	Vcc

Maximum LED Quantity: 100 LEDS  
Consumption: 12V

### Rising Dragon

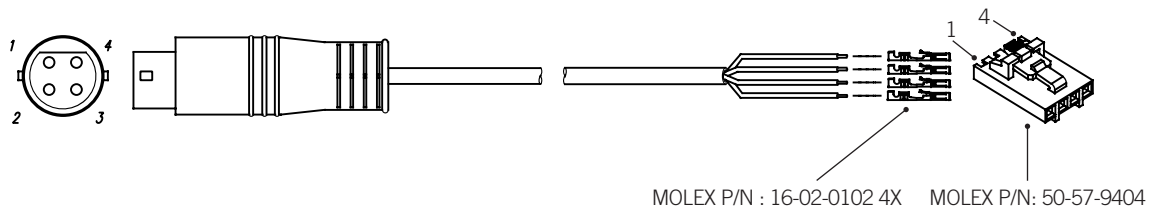

Pin	Function
1 (blue)	BLUE
2 (green)	GREEN
3 (red)	RED
4 (black)	Vcc

Maximum LED Quantity: 120 LEDS  
Consumption: 5V



# Connections

## Other compatible LED lights

### Sloan LED

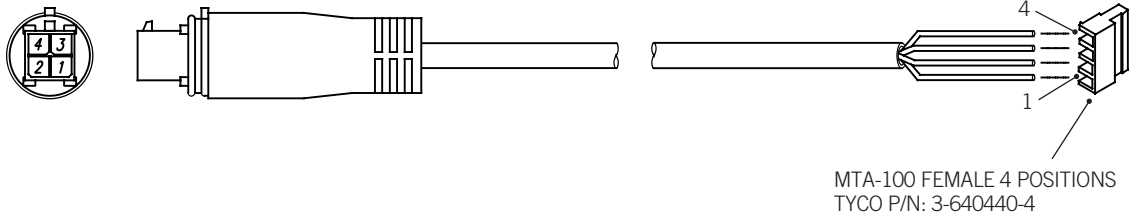

Pin	Function
1 (black)	BLUE
2 (white)	GREEN
3 (green)	RED
4 (red)	Vcc

Maximum LED Quantity: 120 LEDs  
Consumption: 12V

### Proway

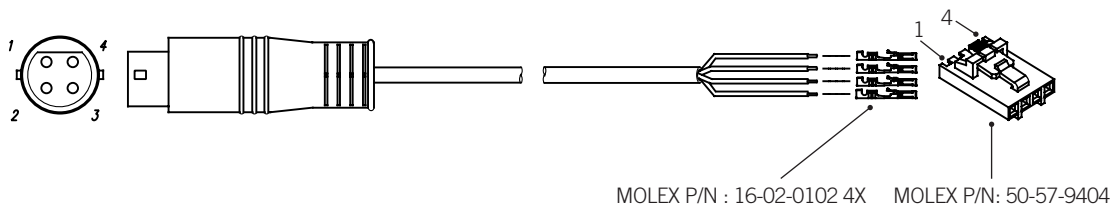

Pin	Function
1 (blue)	BLUE
2 (green)	GREEN
3 (black)	RED
4 (red)	Vcc

Maximum LED Quantity: 120 LEDs  
Consumption: 5V



## Connections

### Other connections

Complete the cabling as follows:

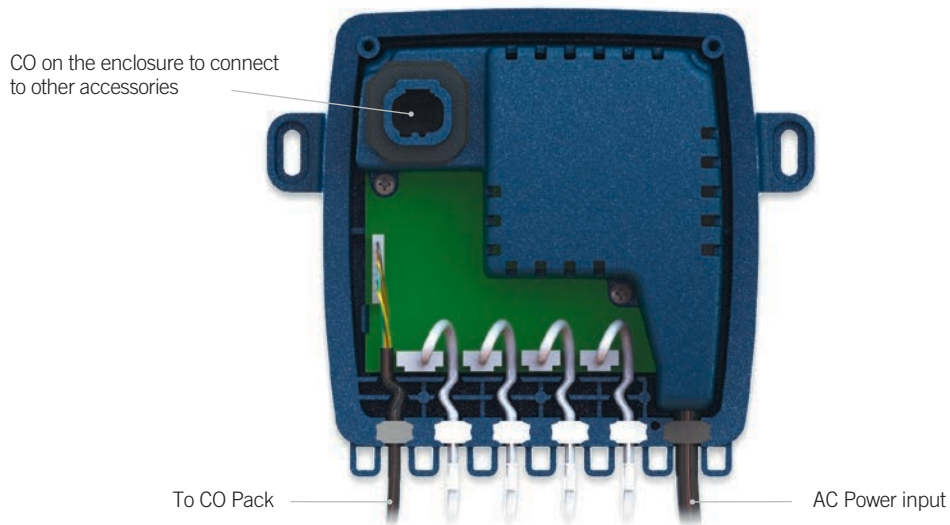

Connect the CO cable of the in.mix 300 to the CO connector of the spa pack. See the documentation related to your specific pack model for more details on this connection.

Connect the AC power cable of the in.mix 300 to a direct output of the spa pack. See the documentation related to your specific pack model for more details on this connection.



---

## Compatible keypads

### List of keypads compatible with in.mix 300

For more information on the keypads compatible with your in.mix 300 refer to the corresponding techbook.



[in.k500 main keypad](#)  
Color LCD display, 7 keys



[in.k800 main keypad](#)  
Color LCD display, 10 keys



[in.k1000 main keypad](#)  
[in.k1000+ main keypad](#)  
Color LCD capacitive  
touchscreen display



[in.k1001 main keypad](#)  
[in.k1001+ main keypad](#)  
Color LCD capacitive  
touchscreen display





## Troubleshooting

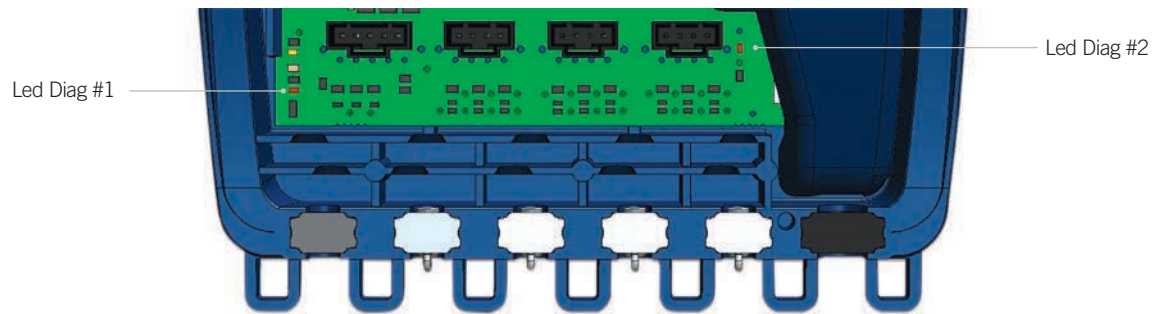

### LED Diagnostic #1

This LED is normally always lit (red). If it is not lit, this indicates a short circuit (or an overload) on the  $V_{CC}$  power supply.

This unit supplies a maximum of 1.6A.

- Turn off the power of the pack and in.mix 300. Verify the Pack Fuse.
- Unplug all outputs (1 to 4).

Turn on the power of the pack as well as in.mix. If the LED lights up then, there is an issue with one of the Zones connected to the in.mix 300.

- Plug the Zone connectors back one by one to see which one is causing the problem.
- If none of them seem to be the source of the problem, there is an issue with the in.mix 300. Replace it.

### LED Diagnostic #2

This LED is normally always lit (red). If not, check if all cables are connected correctly. If all of the connections are verified, replace the in.mix 300 pcb.



## Specifications

Model number	Description	LED 5V	LED 12V	In Molex	In MTA100	IN J&J	Alim 4 pos	Alim in.link
0609-521001	IN.MIX 300-SL-AMP-V-GE1	•		•			•	
0609-521002	IN.MIX 300-SL-IN-5V-GE1	•		•				•
0609-521003	IN.MIX 300-MTA-AMP-12V-GE1		•		•		•	
0609-521004	IN.MIX 300-MTA-IN-12V-GE1		•		•			•
0609-521005	IN.MIX 300-JJ-IN-5V-GE1	•				•		•
0609-521009	IN.MIX-300-LU-ME-AMP-GE1						•	

### Environmental ratings

<b>Operating temperature:</b>	-4 °F (-20 °C) to 140 °F (60 °C)
<b>Storage temperature:</b>	-22 °F (-30 °C) to 185 °F (85 °C)
<b>Humidity:</b>	70% max
<b>Water resistance:</b>	IPX5

### Mechanical

<b>Weight:</b>	1.9 lb (870 g)
<b>Dimensions (W x H x D):</b>	7.03" x 6.13" x 2.22" (179 x 156 x 56 mm)

### Line input

<b>Input voltage:</b>	100-240VAC 50/60 Hz
-----------------------	---------------------

### LED outputs

in.lu.me 5 VDC or 12 VDC output, variable  
3 Independent zones  
4 Connector outputs, can be assigned by low level configuration to any of the zones up to 120 points of light (RGB) in.lu.me (60 on OUT1 and OUT2 and 60 on OUT3 and OUT4)  
up to 78,000 colors \*  
2 Rainbow effects with smooth transition  
plug and play with Gecko in.lu.me, J&J light spider and cluster

### Other connections

Additional CO connector for the other accessories

### Compatibility

Compatible with X and Y series version 2 (-V2)  
Compatible with in.k800 version 6, in.k500 version 19, in.k1000 version 13 or in.k1000+

### UL & CSA certifications

UL1563  
CSA C22.2 No.218.1

\* With in.k1000 & in.k1000+ keypads only. The in.k800 & the in.k500 keypads offer a selection of 10 colors.



---

## Specifications

### European certifications

EN/IEC60335-1  
EN/IEC60335-2

### CEM Europe

EN 55014-1  
EN 55014-2  
EN 61000-3-2  
EN 61000-3-3

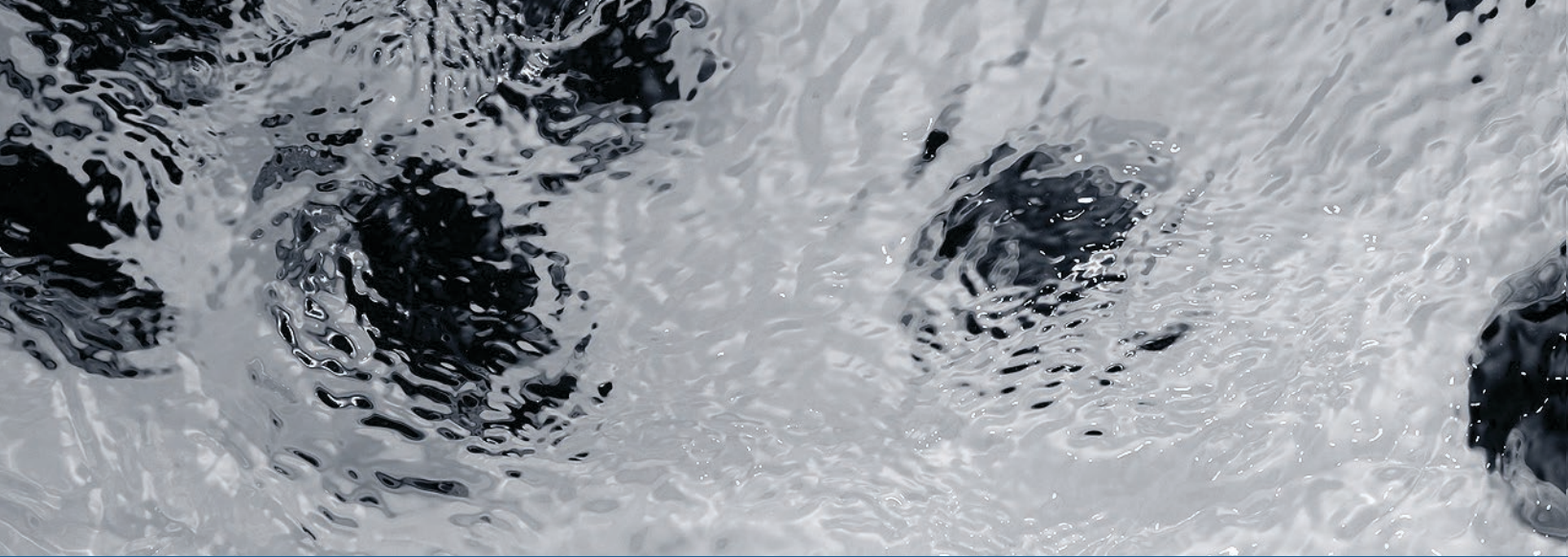

9919-101516-F  
Rev. 07-2022

© Groupe Gecko Alliance inc., 2022  
All trademarks or registered trademarks  
are the property of their respective owners.

Gecko Alliance  
450 des Canetons, Québec (Qc), G2E 5W6 Canada, 1.800.78.GECKO  
[www.geckoalliance.com](http://www.geckoalliance.com)

Printed in Canada